

DUAL KANGAROO - ASSEMBLY INSTRUCTIONS

Assembly Parts list

- A. (1) 5/32 Allen Wrench
- B. (10) Black Screw Covers
- C. (1) 7/16 Wrench
- D. (2) Fender Washers
- E. (2) 1/4-20 x 3.50 Hex Head bolts
- F. (2) Acorn Nuts
- G. (2) Thick Black Washers
- H. (3) 1/4-20 x 7/8 BHCS
- I. (2) 1/4-20 x 3/8 BHCS
- J. (1) Black End Cap
- K. (2) Locking Star Washers

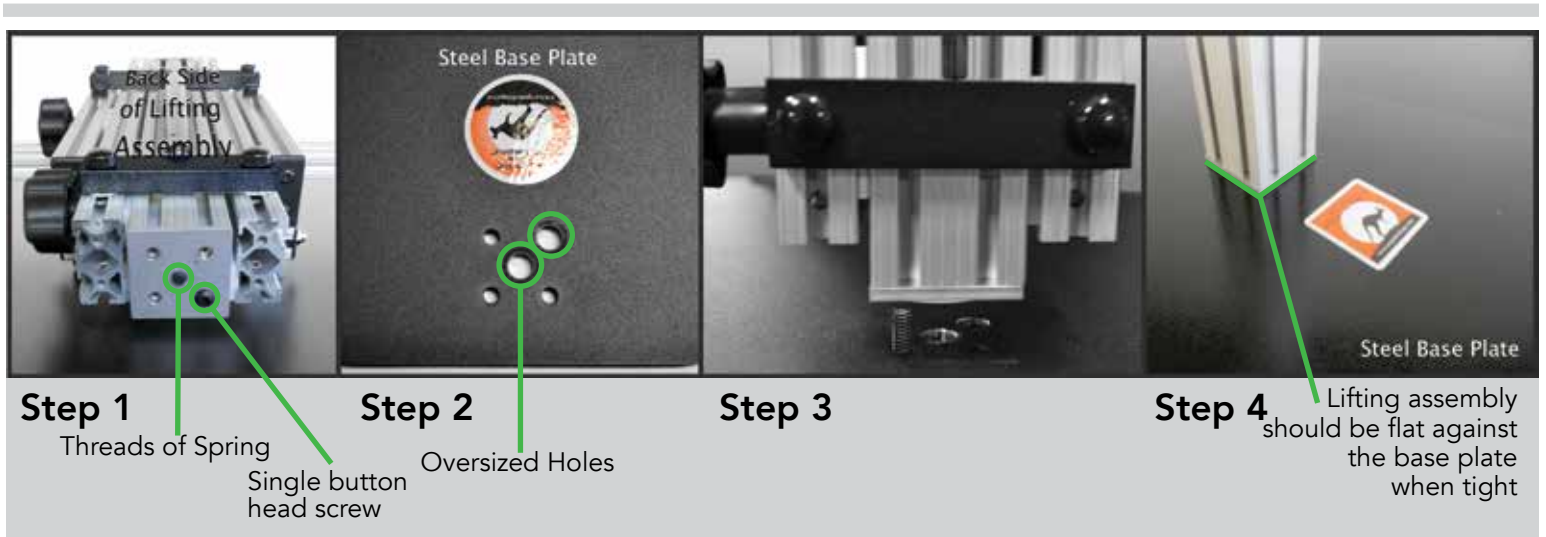

Step 1: Lay the lifting assembly on a solid surface with the back side up as shown. Notice the single Button Head Bolt in the assembly union plate. **DO NOT LOOSEN THE SINGLE BUTTON HEAD BOLT THAT IS NOTATED.**

Step 2: Notice the (2) oversized holes in the Base Plate. The Single Button Head Bolt will go into the oversized hole on the top right, while the other 3 holes should line up with the base. The center oversized hole is not used with this unit.

Step 3: With the Base Plate over hanging the table about 2 inches, hold the Lifting Assembly above the Base Plate and align the Single Button Bolt into the oversized hole. Place one 1/4-20 x 7/8 BHCS{F} through the base plate to screw in the lifting assembly.

Step 4: Insert and thread the other (2) 1/4-20 x 7/8 BHCS{F} through the Base Plate and into the Lifting Assembly. Once all (3) bolts are threaded in, tighten securely with the 5/32 allen wrench{C}. Lifting Assembly should be flat against the Base and all three bolts should look like the picture above.

THE DUAL KANGAROO - ASSEMBLY INSTRUCTIONS



Step 5: Put (1) Locking Star Washer{I} on each of the 1/4 -20 x 3.50 Hex Head Bolts{B}.

Step 6: Insert the (2) 1/4-20 x 3.50 Hex Head Bolts{B} through the holes in the Vertical Rail.

Step 7: Put (1) Fender Washer{D} on each of the 1/4-20 x 3.50 Hex Head Bolts{B} on the other side of the Vertical Rail.

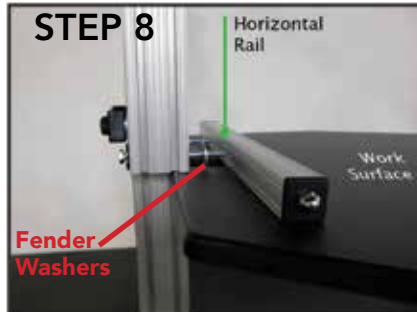

Step 8: Lift the Work Surface up and align the holes in the Horizontal Rail with the (2) 1/4-20 x 3.50 Hex Head Bolts{B}. Push the Work Surface onto the Hex Head Bolts until the threads of the bolts come through the Horizontal Rail.



Step 9: Put (1) Black Washer{G} and (1) Acorn Nut{E} on the end of each of the Hex Head Bolts. Using the 7/16 wrench{H} tighten the Acorn Nuts securely.

STEP 10

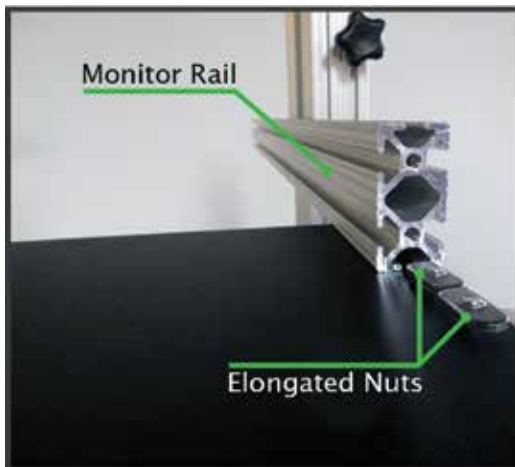

Step 10: Position one of the black shelves as shown. Have the elongated nuts loose and in line with the bottom channel of the monitor rail. Slide the elongated nuts into the monitor rail to you desired position and then tighten the bolts using the 7/16 wrench. Attach both shelves this way.

STEP 11



Step 11: Attach black end cap using the (2) 1/4-20 x 3/8 Button Head Cap Screws. Gently tighten with the 5/32 allen wrench.

THE DUAL KANGAROO

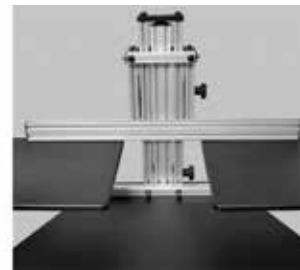
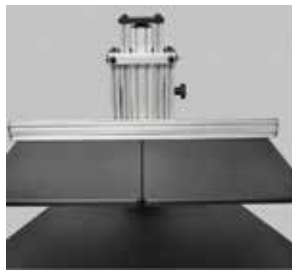

Loosen the bolts under the shelves just enough to allow the shelf to move(usually half a turn).

Your Dual Kangaroo is shipped with the two monitor shelves pushed together. Depending on the size of the monitors you are going to use, you may need to spread them out to allow your monitors to sit properly.

Underneath the shelves you will find four bolts in each shelf. Loosen the bolts just a little(usually half a turn) and this will allow the shelves to slide apart. Once you have them where you like, just tighten the bolts. You will need a 7/16 wrench or an adjustable wrench.

Always push down with both hands on the horizontal rear rail when lowering the work surface.

HOW TO USE THE DUAL KANGAROO

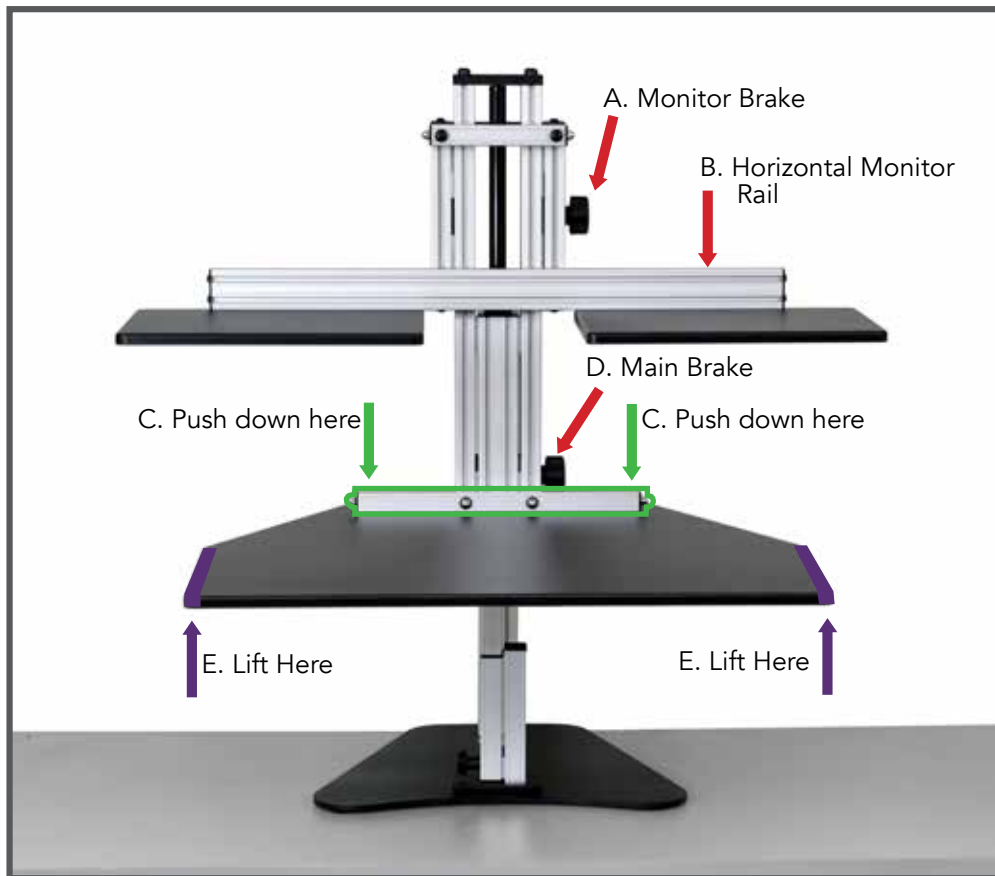

To raise the Dual, loosen the main brake(D) and lift the main work surface on the sides(E & E).

To lower the Dual, loosen the main brake(D) and lean into the unit using your upper body weight pushing down with both hands on the horizontal bar at the rear of the main work surface(C & C).

Raise and lower the monitor shelves by loosening the monitor brake(A) and either lift up or push down on the monitor rail(B).

A. Monitor Brake

B. Horizontal Monitor Rail

C. Work Surface Rail

D. Main Brake

E. Main Work Surface

ADJUST THE STOPPING BOLT

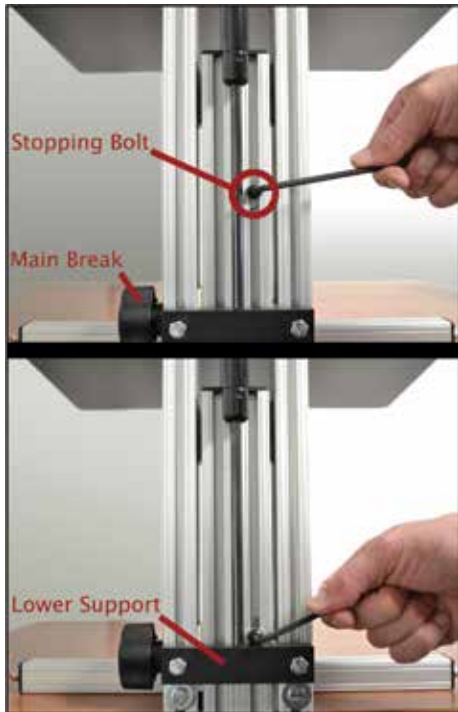

On the back side of your unit you will notice a small bolt located on the lifting tower. This bolt is used as our work surface stopper. It is currently set at 15", the highest our unit should go. This setting is for a 6'2" user on a 30" high desk. If you are shorter than this, raise the unit to your desired height and tighten the Main Brake. Adjust the stopping bolt by loosening the bolt **with one turn** and drop the bolt down to reach the lower support, and re-tighten the stopping bolt.

If you are a taller individual and need to raise the stopping bolt, please note that the work surface can get up to 16 1/2 inches but you will be raising the unit into the oil dampening zone of the spring. This makes it a little more difficult to lower the unit into the seated position when raised to this maximum point.

Our work surface should only be raised to your belt or navel line. This creates a 90-110 degree angle in your elbows which is suggested in the standing position. This will also allow you to lower the unit with ease by simply transferring your upper body weight into the back of the unit.

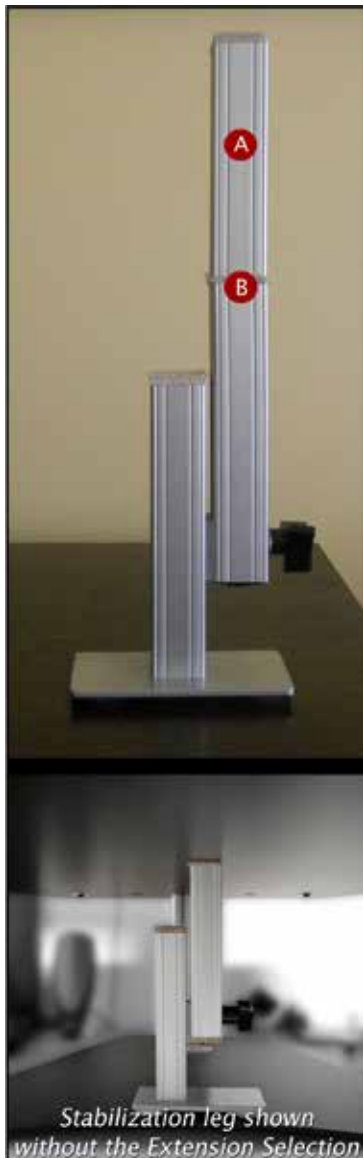

THE STABILIZATION LEG

Your adjustable height desk top unit comes with an adjustable leg that can be used to give you maximum stability when you are using "The Kangaroo" in the standing position.

Raise the Kangaroo work surface to your desired standing height and tighten the work surface brake.

Place the adjustable leg under the work surface and loosen the adjustable leg brake. Only loosen the brake by a turn or two, too much and the brake will disengage from the slot.

Extend the adjustable leg until it engages the bottom of the work surface and then tighten the adjustable leg brake.

The leg is shipped with the extension section installed to give you additional height adjustment. If this is too tall for your application, simply unscrew the extension selection.

A Extension selection

B Screws into here

ALWAYS REMEMBER TO REMOVE THE STABILIZATION LEG BEFORE LOWERING YOUR WORK SURFACE